

CHIEF'S SHOP PLAN OF THE WEEK



PATIO CONTEMPLATION BENCH



WHAT YOU'LL NEED



LUMBER

6 - 2x4x8
2 - 2x6x8
(availability will vary)

HARDWARE/SUPPLIES

Kreg 2 1/2" pocket hole screws
wood glue
wood filler, choice of finish

TOOLS

table saw, miter saw, jigsaw
sander/belt sander
drill/driver
Kreg Jig
clamps
square

ABOUT THESE PLANS

On this first page you will see above the project complete. On one of the last two pages you'll find the finished outer dimensions. Be sure to read ALL of the project steps before you start.

To the right is a list of the Lumber, Hardware/Supplies, and Tools you will need to complete this project. A measuring tape and pencil are not included because that should be pretty standard and self explanatory.

Below What You'll Need is the Parts list. This also is included on the Cutting Diagram page, which is the last page of this plan document. Also on the Cutting Diagram page is an estimate of the cost of the lumber. This estimate doesn't include any other supplies and does not factor in sales tax.

Throughout these plans you'll find the icons below:



LAYOUT

This indicates a diagram detailing the dimensions of a project part and/or the placement for pocket holes, screws, nails, etc.



NOTE

Notes are the instructions for a particular step/section of the project.



TAKE CARE!

This indicates when to pay close attention to the diagrams, take precautions for safety, etc.



MORE PLANS

Want more Chief's Shop plans? Visit chiefs-shop.com and look through the Plans section.

Be sure to "Like" Chief's Shop on facebook by heading over to [facebook.com/ChiefsShop](https://www.facebook.com/ChiefsShop).

PARTS

stiles (4) - 1 1/2 x 1 1/2 x 14
handles (2) - 1 x 14
top end rails (2) - 3/4 x 3 1/2 x 9
bottom end rails (2) - 3/4 x 5 1/2 x 9
top side rails (2) - 3/4 x 3 1/2 x 16
bottom side rails (2) - 3/4 x 5 1/2 x 16
slats (2) - 3/4 x 4 3/8 x 16 3/4

All parts are listed in actual dimensions. Refer to the Cutting Diagram on the last page of this plan as a guide for determining the specific board from which to cut the parts.

VIDEO

Check out Chief's Shop Videos on YouTube. ([click here](#))

PATIO CONTEMPLATION BENCH

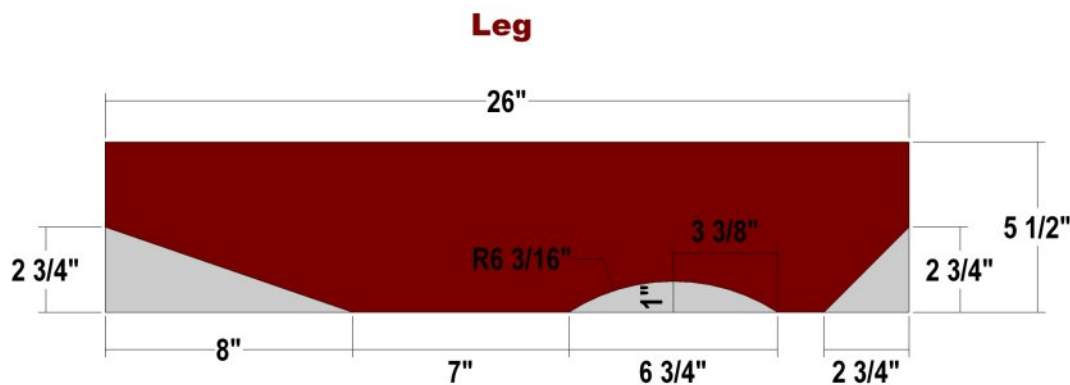

LAYOUT

NOTE

Use the layout for creating the Legs. Use a jigsaw to cut the long taper and the arc. The short taper is a 45-degree angle and can be cut on a miter saw.

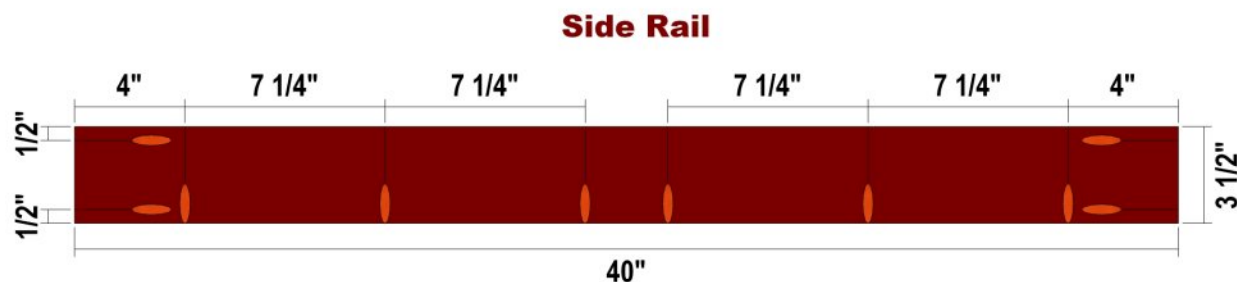

NOTE

Use the layout for creating the Side Rails. Set your Kreg Jig and drill bit for 1 1/2" stock.

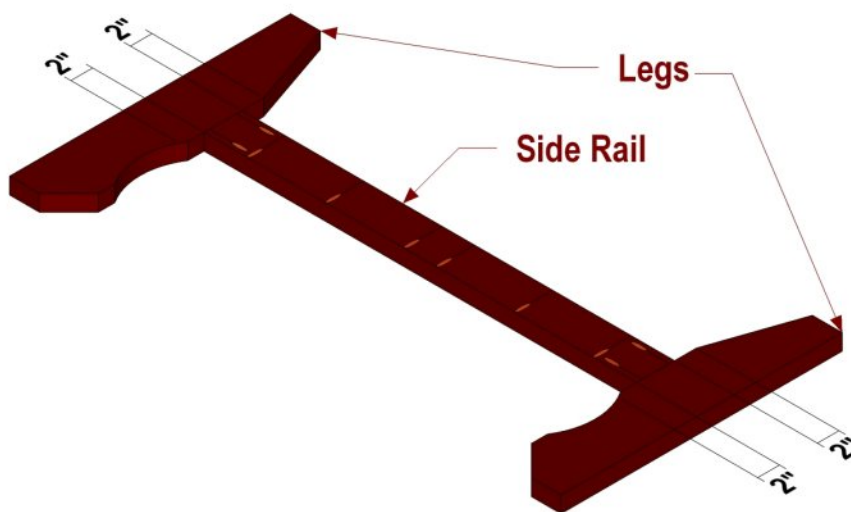

NOTE

Apply glue to the ends of the Side Rail, position as shown, and attach using 2 1/2" pocket hole screws. Create two assemblies.



End Rail

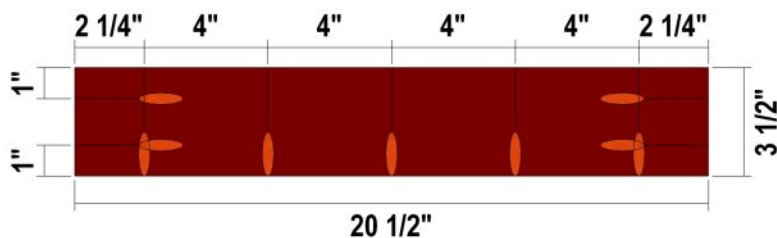

Stretcher

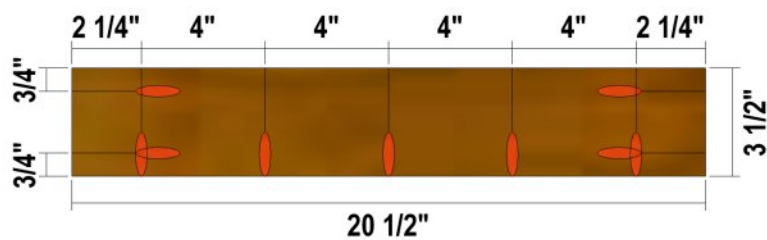

Arm Rail

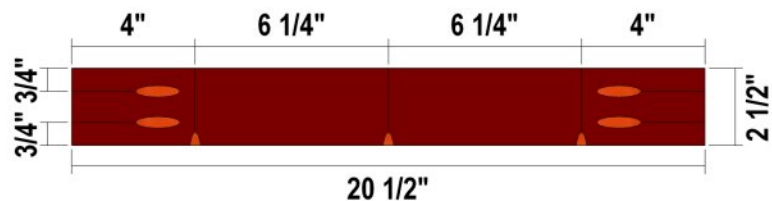

Use the layouts for creating the End Rails, Stretcher, and Arm Rails. Set your Kreg Jig and drill bit for 1 1/2" stock.

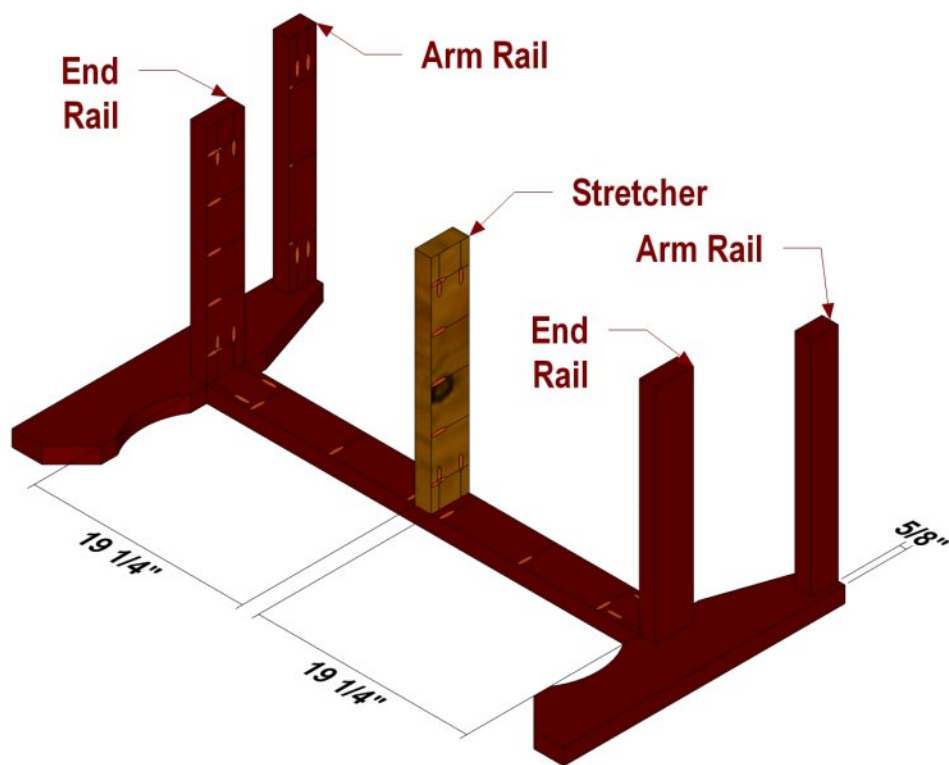

NOTE

Apply glue to the ends of the End Rails, Stretcher, and Arm Rails, position as shown, and attach using 2 1/2" pocket hole screws. Attach this assembly to the second Side Rail/Legs Assembly to create the Base Assembly.

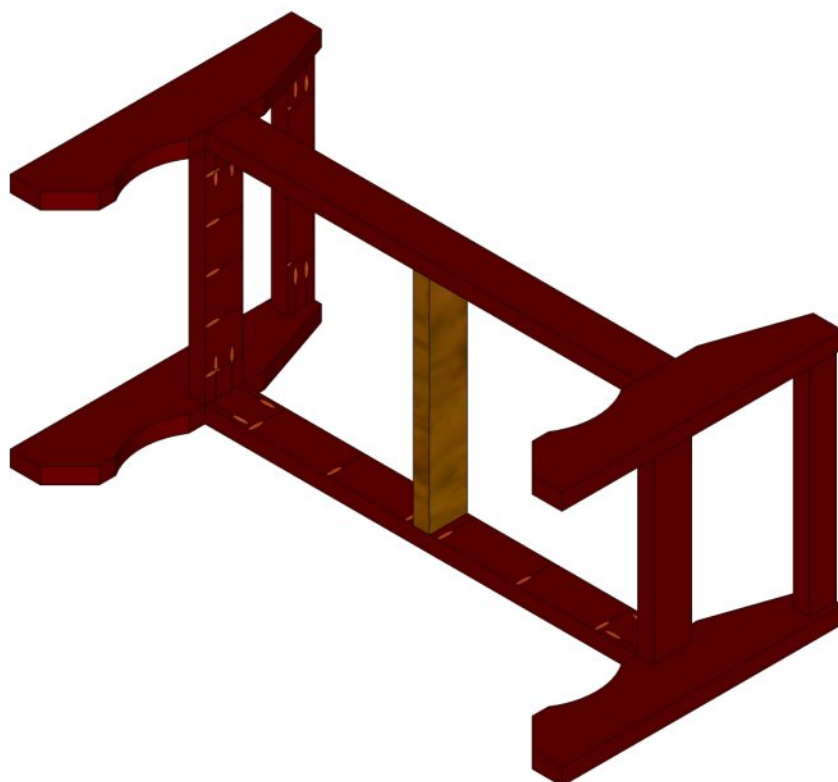

Arm Rest



LAYOUT

NOTE

Use the layout for creating the Arm Rests. The miters on the corners are 45-degrees.

NOTE

Apply glue to the top of the Arm Rails and Legs, position the Arm Rests as shown, and attach using 2 1/2" pocket hole screws (driven through the Arm Rails and into the Arm Rests).

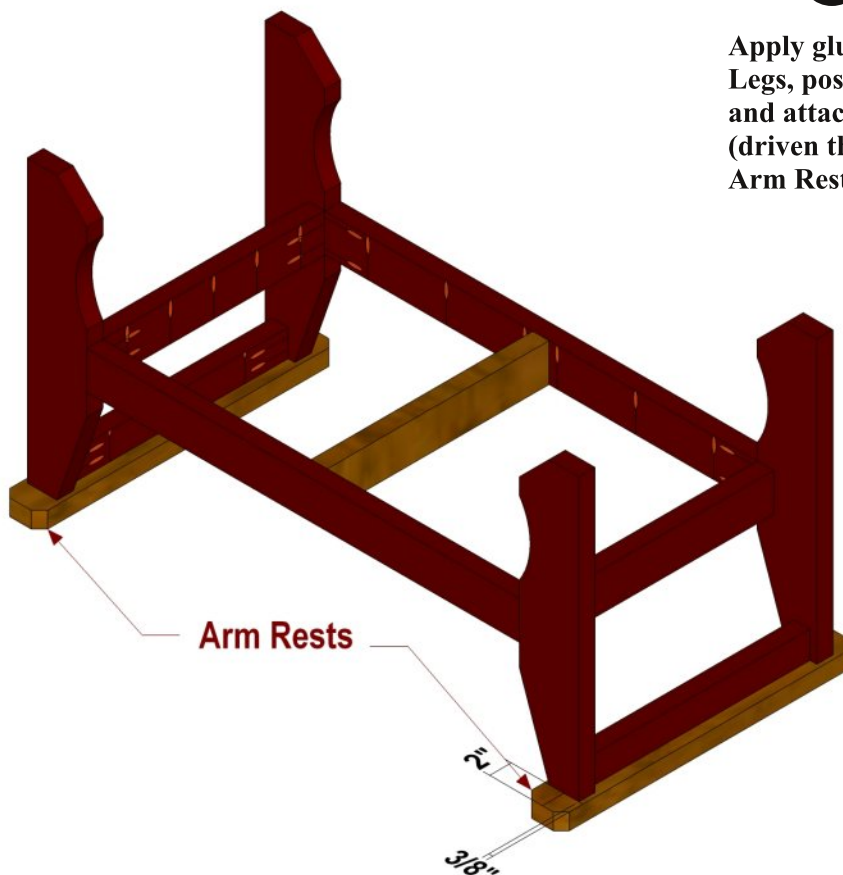

Outer Seat Slat

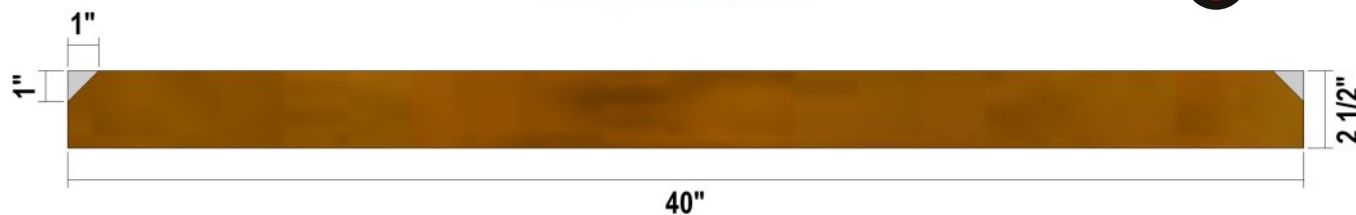

Use the layout for creating the Outer Seat Slats. The miters on the corners are 45-degrees.



Apply glue to the top of the Side and End Rails and Stretcher, and position the Outer Seat Slats and the five Seat Slats as shown here and on the next page, and attach using 2 1/2" pocket hole screws.

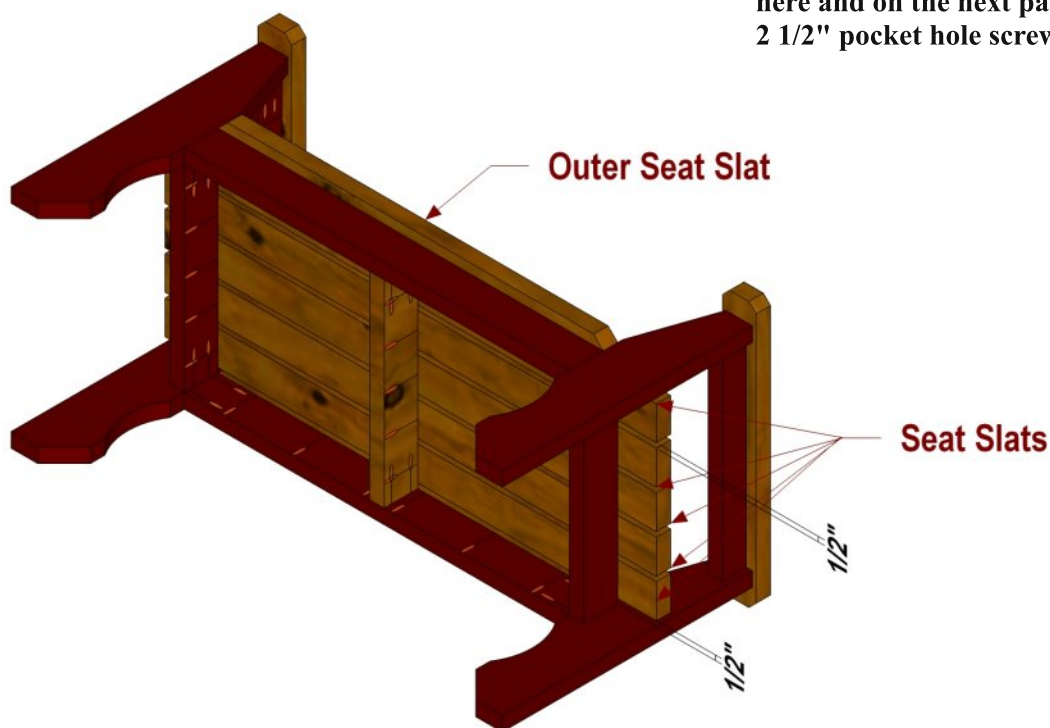

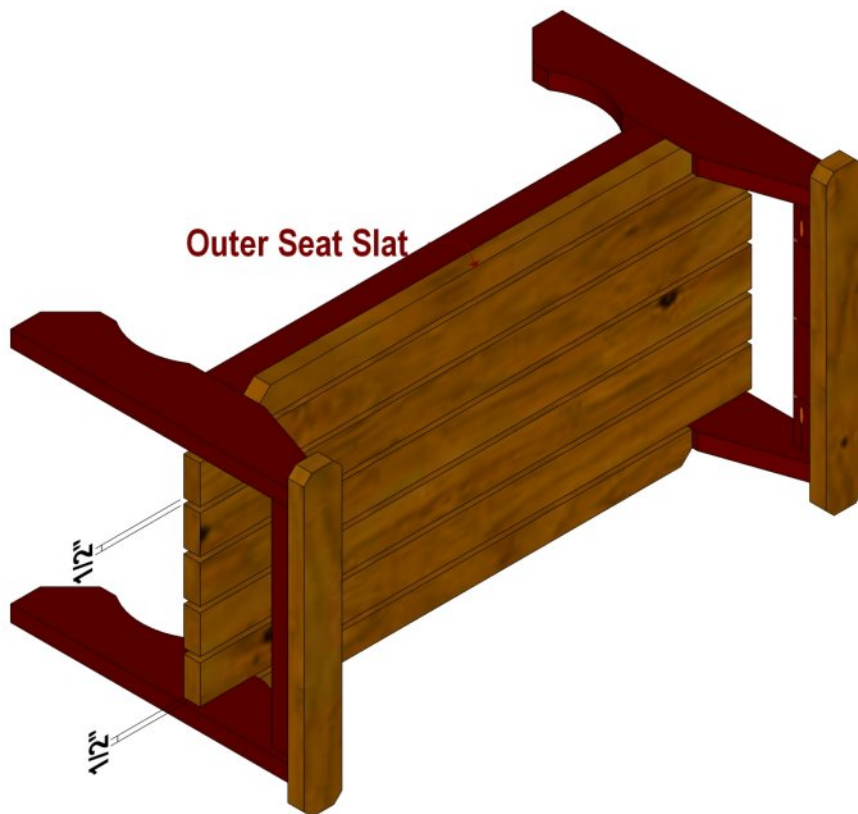

 **CUTTING DIAGRAM**

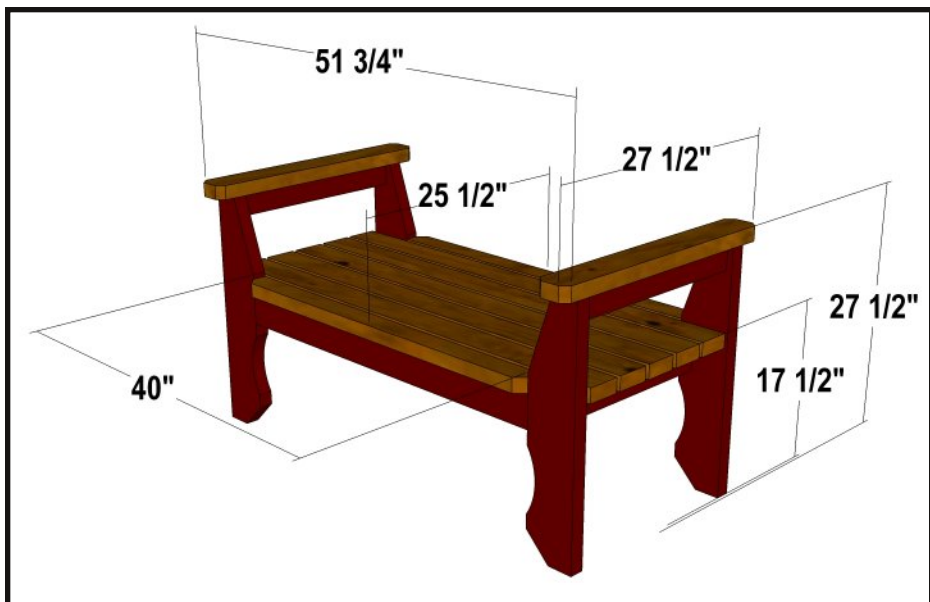
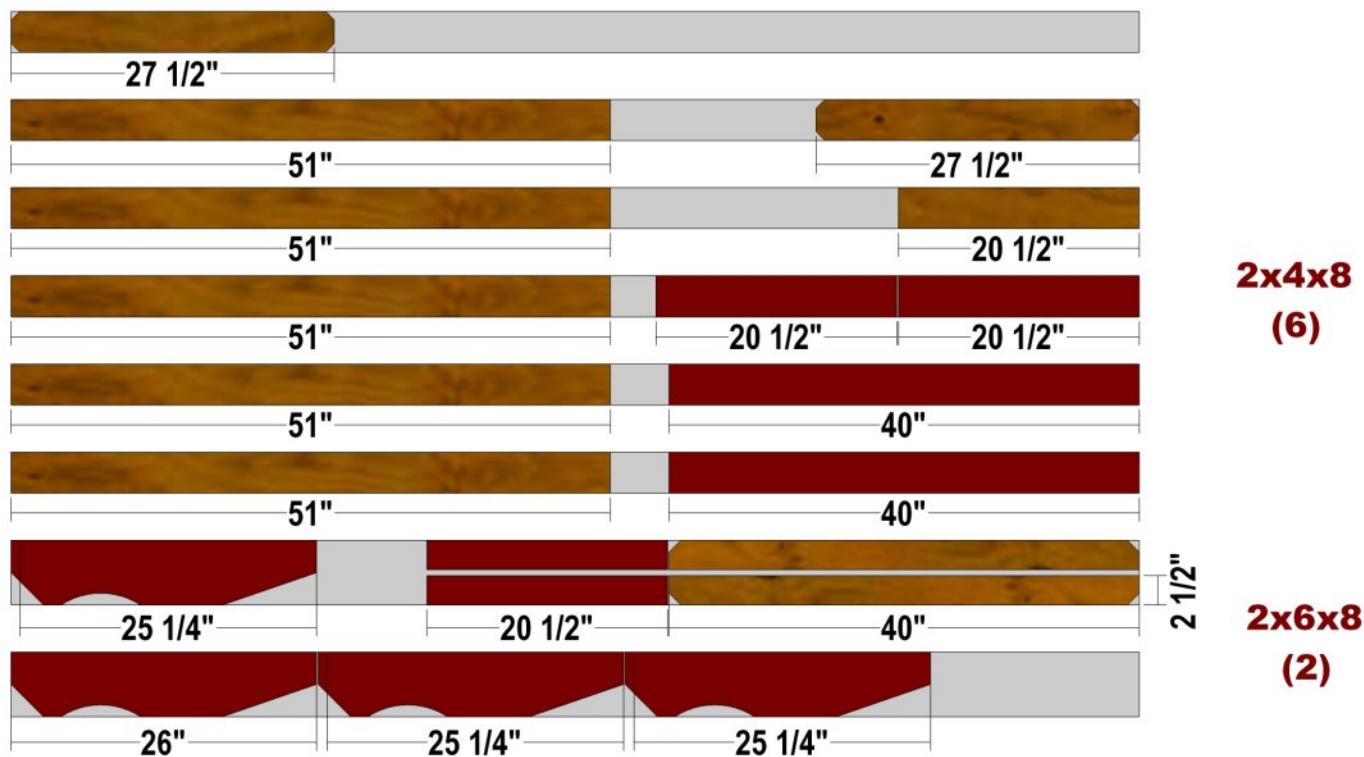

Estimated lumber cost:
starting at \$35
treated pine

✚ PARTS ✚

- legs (4) - 1 1/2 x 5 1/2 x 25 1/4
- side rails (2) - 1 1/2 x 3 1/2 x 40
- end rails (2) - 1 1/2 x 3 1/2 x 20 1/2
- stretcher (1) - 1 1/2 x 3 1/2 x 20 1/2
- arm rails (2) - 1 1/2 x 2 1/2 x 20 1/2
- arm rests (2) - 1 1/2 x 3 1/2 x 27 1/2
- outer seat slats (2) - 1 1/2 x 2 1/2 x 40
- seat slats (2) - 1 1/2 x 3 1/2 x 51

All parts are listed in actual dimensions. Refer to the Cutting Diagram on the last page of this plan as a guide for determining the specific board from which to cut the parts.

⚠ TAKE CARE!

Follow ALL SAFETY GUIDELINES AND RECOMMENDATIONS provided by the manufacturers of your tools, and any chemicals such as glue and finishes you use in this project. YOU are responsible for your safety, so use common sense when working in the shop!