

# CHIEF'S SHOP PLAN OF THE WEEK



## KITCHEN UTILITY STOOL



### WHAT YOU'LL NEED

#### LUMBER

3 - 2x4x8

1 - 2x8x8

*(availability will vary, lumber is enough to create one bench, plus a few additional parts)*

#### HARDWARE/SUPPLIES

Kreg 2 1/2" pocket hole screws  
wood glue, wood filler,  
pocket hole plugs, choice of finish

#### TOOLS

miter saw  
sander/belt sander  
drill/driver  
Kreg Jig  
clamps  
square

### ABOUT THESE PLANS

On this first page you will see above the project complete. On one of the last two pages you'll find the finished outer dimensions. Be sure to read ALL of the project steps before you start.

To the right is a list of the Lumber, Hardware/Supplies, and Tools you will need to complete this project. A measuring tape and pencil are not included because that should be pretty standard and self explanatory.

Below What You'll Need is the Parts list. This also is included on the Cutting Diagram page, which is the last page of this plan document. Also on the Cutting Diagram page is an estimate of the cost of the lumber. This estimate doesn't include any other supplies and does not factor in sales tax.

Throughout these plans you'll find the icons below:



**LAYOUT** This indicates a diagram detailing the dimensions of a project part and/or the placement for pocket holes, screws, nails, etc.



**NOTE** Notes are the instructions for a particular step/section of the project.



**TAKE CARE!** This indicates when to pay close attention to the diagrams, take precautions for safety, etc.



#### MORE PLANS

Want more Chief's Shop plans? Visit [chiefs-shop.com](http://chiefs-shop.com) and look through the Plans section.

Be sure to "Like" Chief's Shop on facebook by heading over to [facebook.com/ChiefsShop](https://www.facebook.com/ChiefsShop).

### PARTS

legs (4) - 1 1/2 x 3 1/2 x 16 9/16  
top end rails (2) - 1 1/2 x 3 1/2 x 10 5/8  
bottom end rails (2) - 1 1/2 x 3 1/2 x 16  
side rails (2) - 1 1/2 x 3 1/2 x 33  
top stretchers (2) - 1 1/2 x 3 1/2 x 10 5/8  
bottom stretcher (1) - 1 1/2 x 3 1/2 x 33  
wide slats (2) - 1 1/2 x 7 1/4 x 39  
narrow slat (1) - 1 1/2 x 3 1/2 x 39

*All parts are listed in actual dimensions. Refer to the Cutting Diagram on the last page of this plan as a guide for determining the specific board from which to cut the parts.*

### VIDEO

Check out Chief's Shop Videos on YouTube. ([click here](#))

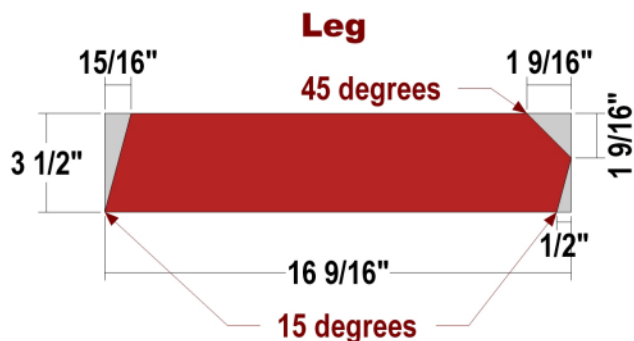

Use the layout for creating the Legs.

## Top End Rail

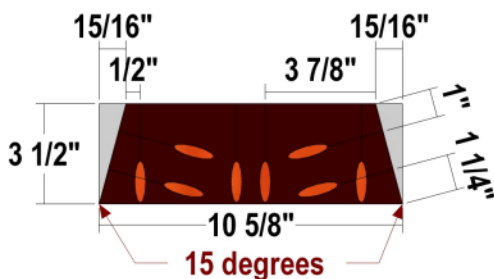

Use the layout for creating the Top End Rails and Bottom End Rails. **Set your Kreg Jig and drill bit for 1 1/2" stock for the pocket holes. Cut the angled ends before drilling the holes on the ends.**

## Bottom End Rail

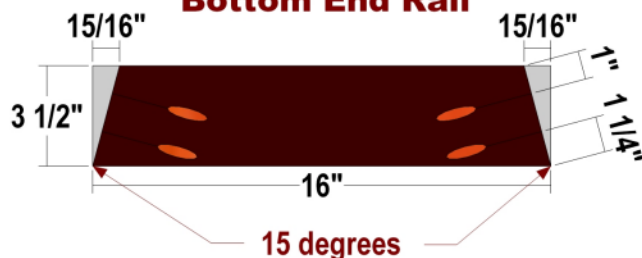

Apply glue to the ends of the Top End Rails and Bottom End Rails, position as shown, and attach to the Front Rail using 2 1/2" pocket hole screws. Create two assemblies.

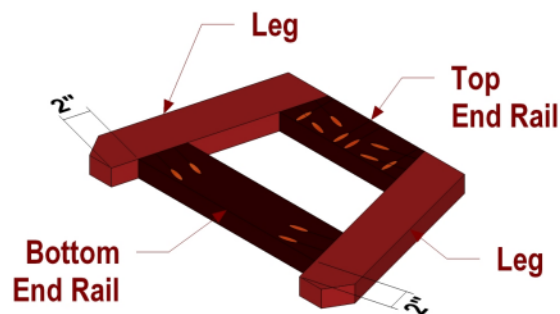

## Side Rail

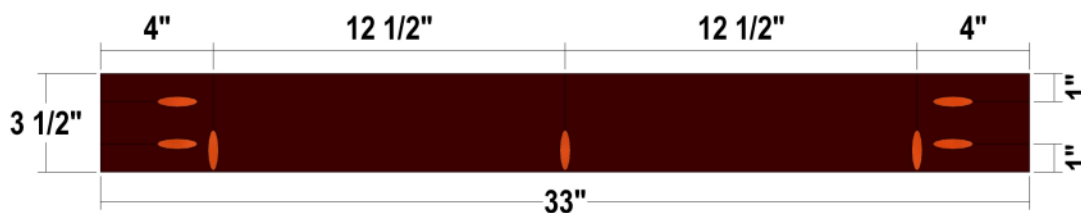

## Top Stretcher

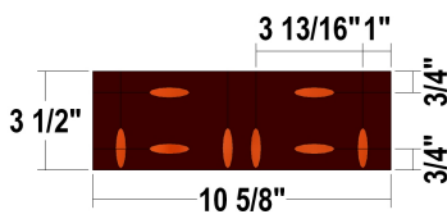

Use the layout for creating the Side Rails and Top Stretchers. Set your Kreg Jig and drill bit for 1 1/2" stock for the pocket holes.

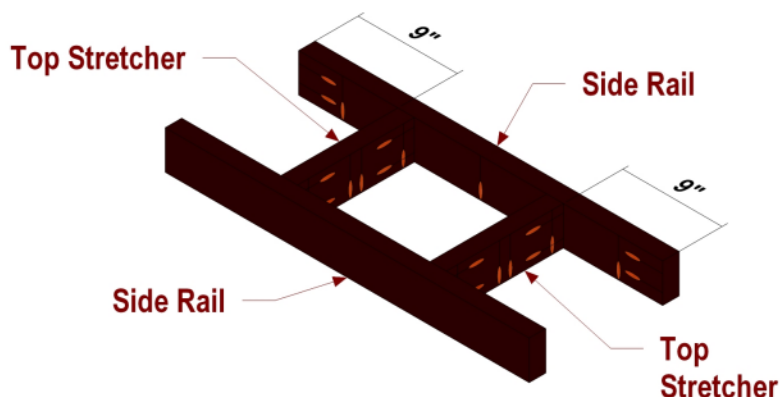

Apply glue to the ends of the Top Stretchers, position as shown, and attach using 2 1/2" pocket hole screws.

## Bottom Stretcher

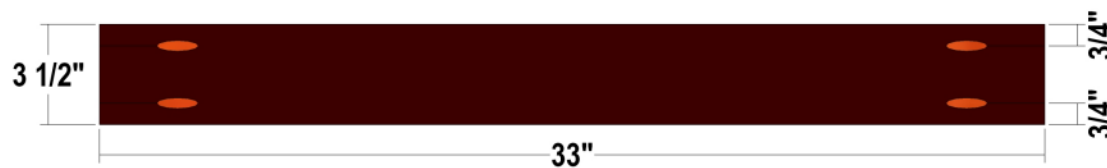

Use the layout for creating the Bottom Stretcher. Set your Kreg Jig and drill bit for 1 1/2" stock for the pocket holes.

 **NOTE**

Apply glue to the ends of the Side Rails and Bottom Stretcher, position as shown, and attach to the Front Rail using 2 1/2" pocket hole screws.

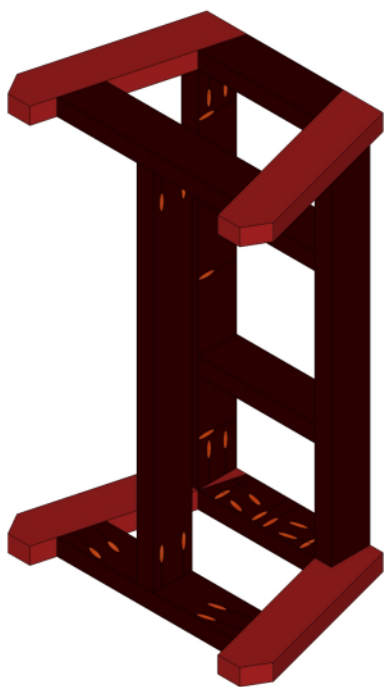
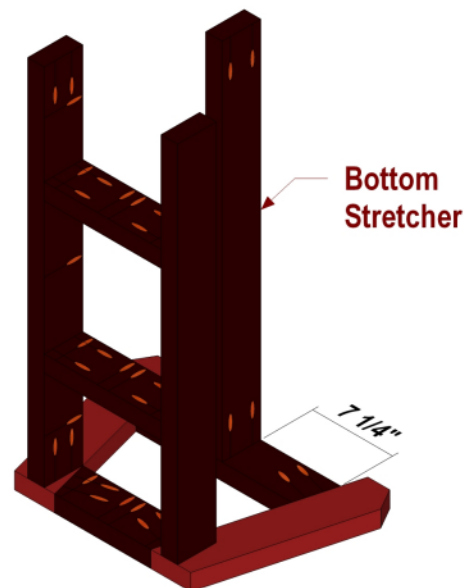

 **NOTE**

Apply glue to the other ends of the Side Rails and Bottom Stretcher, position as shown, and attach to the Front Rail using 2 1/2" pocket hole screws.

## Wide Slat

## LAYOUT

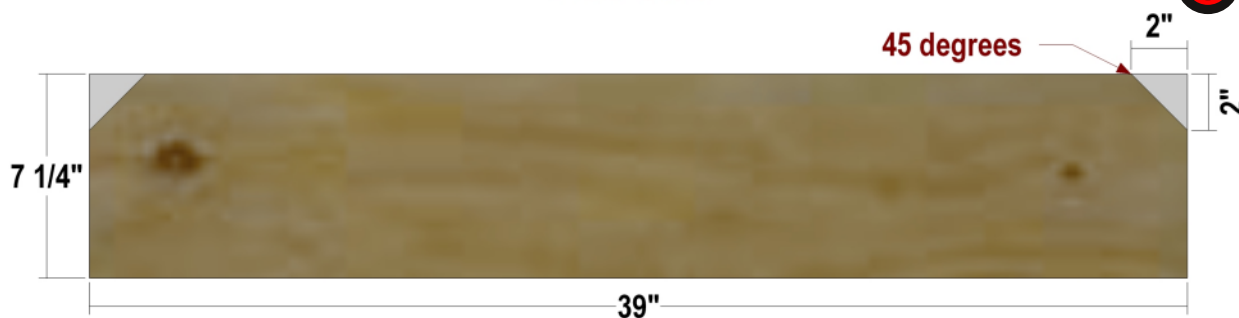

## NOTE

Use the layout for creating the Wide Slats.

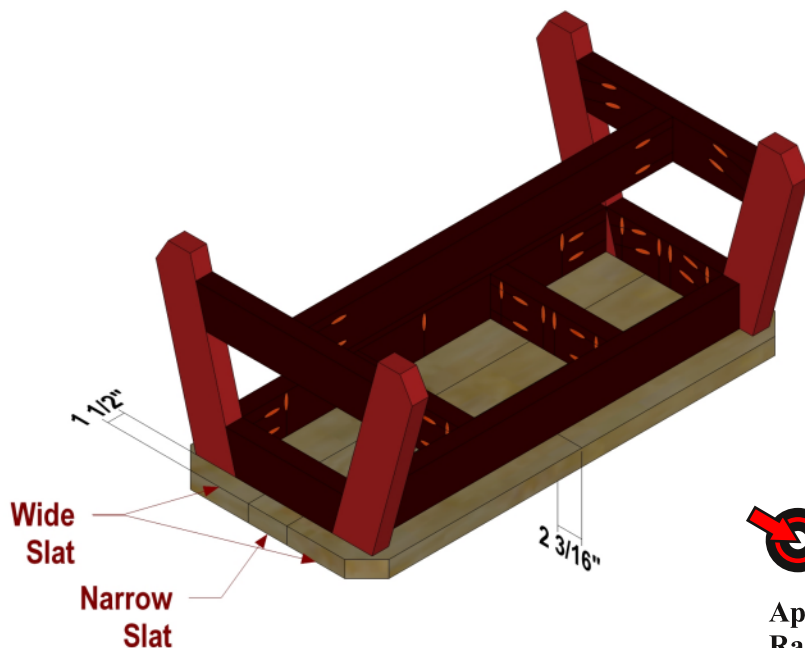

## NOTE

Apply glue to the top edges of the Top End Rails, Side Rails, and Top Stretchers, as well as the top ends of the Legs, position the assembly on the Wide Slats and Narrow Slats as shown at left, and attach using 2 1/2" pocket hole screws.

 **CUTTING DIAGRAM**

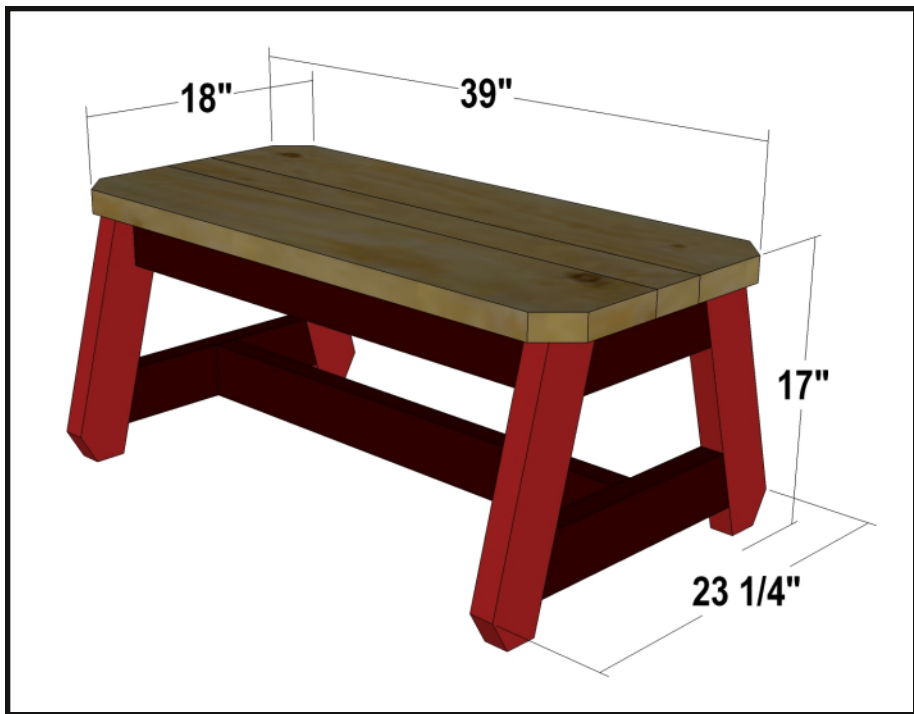
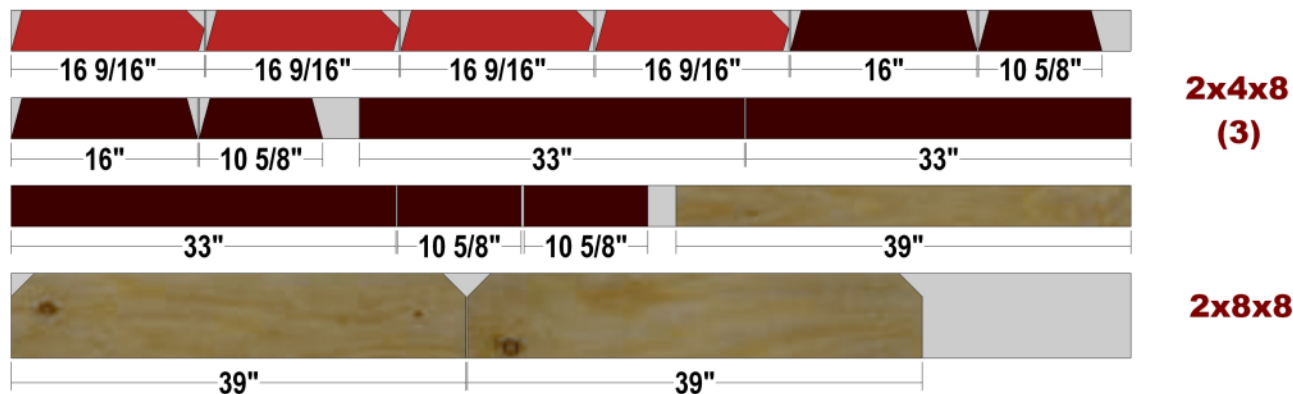

Estimated lumber cost:  
starting at \$15 for one

**✚ PARTS ✚**

- legs (4) - 1 1/2 x 3 1/2 x 16 9/16
- top end rails (2) - 1 1/2 x 3 1/2 x 10 5/8
- bottom end rails (2) - 1 1/2 x 3 1/2 x 16
- side rails (2) - 1 1/2 x 3 1/2 x 33
- top stretchers (2) - 1 1/2 x 3 1/2 x 10 5/8
- bottom stretcher (1) - 1 1/2 x 3 1/2 x 33
- wide slats (2) - 1 1/2 x 7 1/4 x 39
- narrow slat (1) - 1 1/2 x 3 1/2 x 39

All parts are listed in actual dimensions. Refer to the Cutting Diagram on the last page of this plan as a guide for determining the specific board from which to cut the parts.

**✚ TAKE CARE!**

Follow ALL SAFETY GUIDELINES AND RECOMMENDATIONS provided by the manufacturers of your tools, and any chemicals such as glue and finishes you use in this project. YOU are responsible for your safety, so use common sense when working in the shop!