

# CHIEF'S SHOP PLAN OF THE WEEK



## BEACH RESORT CHAIR



### WHAT YOU'LL NEED



#### LUMBER

5 - 2x4x8  
2 - 2x6x8  
1 - 5/4x6x8 decking  
*(availability will vary)*

#### HARDWARE/SUPPLIES

Kreg 2 1/2" pocket hole screws  
2 1/2" deck screws  
wood glue, wood filler,  
pocket hole plugs, choice of finish

#### TOOLS

miter saw, jigsaw  
sander/belt sander  
drill/driver  
Kreg Jig  
clamps  
compass  
square

### ABOUT THESE PLANS

On this first page you will see above the project complete. On one of the last two pages you'll find the finished outer dimensions. Be sure to read ALL of the project steps before you start.

To the right is a list of the Lumber, Hardware/Supplies, and Tools you will need to complete this project. A measuring tape and pencil are not included because that should be pretty standard and self explanatory.

Below What You'll Need is the Parts list. This also is included on the Cutting Diagram page, which is the last page of this plan document. Also on the Cutting Diagram page is an estimate of the cost of the lumber. This estimate doesn't include any other supplies and does not factor in sales tax.

Throughout these plans you'll find the icons below:



### LAYOUT

This indicates a diagram detailing the dimensions of a project part and/or the placement for pocket holes, screws, nails, etc.



### NOTE

Notes are the instructions for a particular step/section of the project.



### TAKE CARE!

This indicates when to pay close attention to the diagrams, take precautions for safety, etc.



### MORE PLANS

Want more Chief's Shop plans? Visit [chiefs-shop.com](http://chiefs-shop.com) and look through the Plans section.  
Be sure to "Like" Chief's Shop on facebook by heading over to [facebook.com/ChiefsShop](https://www.facebook.com/ChiefsShop).

### VIDEO

Check out Chief's Shop Videos on YouTube. ([click here](#))

### PARTS

front legs (2) - 1 1/2 x 5 1/2 x 24 3/8  
back legs (2) - 1 1/2 x 5 1/2 x 22 9/16  
arm rails (2) - 1 1/2 x 3 1/2 x 11 5/8  
outer arm supports (2)  
- 1 1/2 x 3 1/2 x 26 7/8  
left rail - 1 1/2 x 3 1/2 x 21 3/4  
right rail - 1 1/2 x 3 1/2 x 21 3/4  
side rails (2) - 1 1/2 x 3 1/2 x 24  
back rail - 1 1/2 x 3 1/2 x 28  
back slats (3) - 1 1/2 x 5 1/2 x 20  
back support - 1 1/2 x 3 1/2 x 27  
stretcher - 1 1/2 x 3 1/2 x 21 3/4  
back support - 1 1/2 x 3 1/2 x 27  
seat slats (7) - 1 1/2 x 3 1/2 x 24  
arms (2) - 1 x 5 1/2 x 32 7/8

All parts are listed in actual dimensions. Refer to the Cutting Diagram on the last page of this plan as a guide for determining the specific board from which to cut the parts.

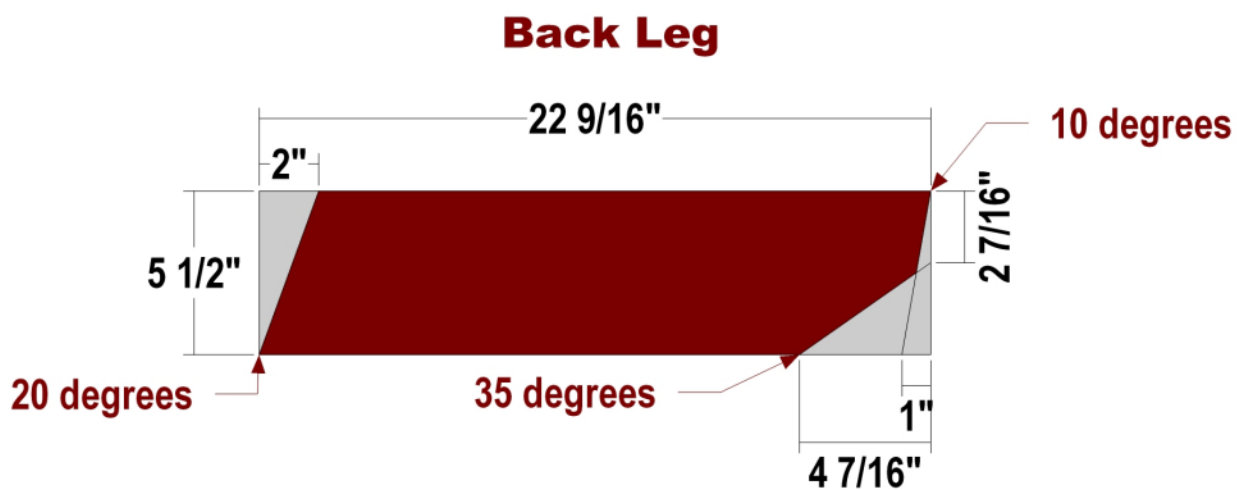
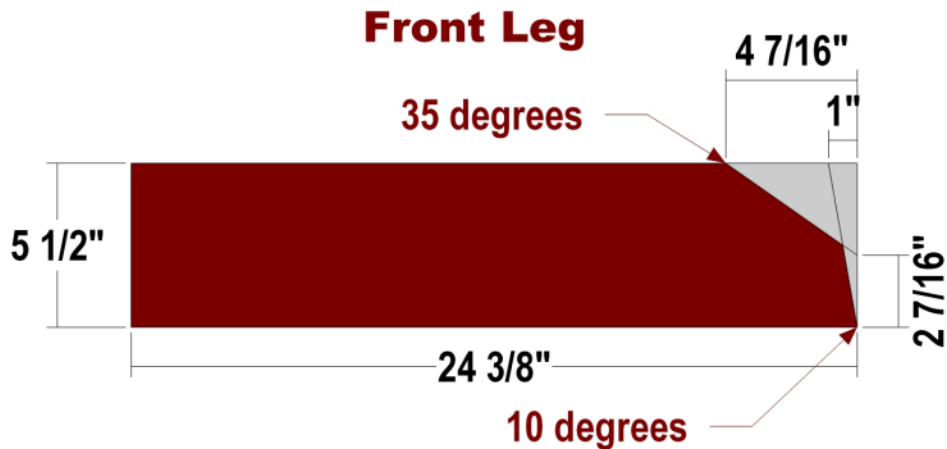

**NOTE**

Use the layouts for creating the Front Legs and Back Legs.

Arm Rails

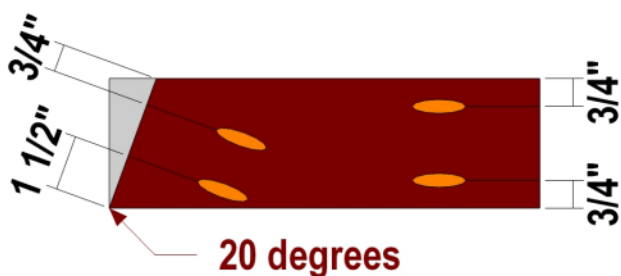
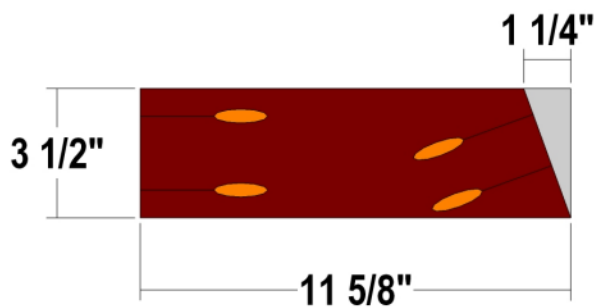

**NOTE**

Use the layout for creating the Arm Rails. Set your Kreg Jig and drill bit for 1 1/2" stock for the pocket holes. Create one of each layout.

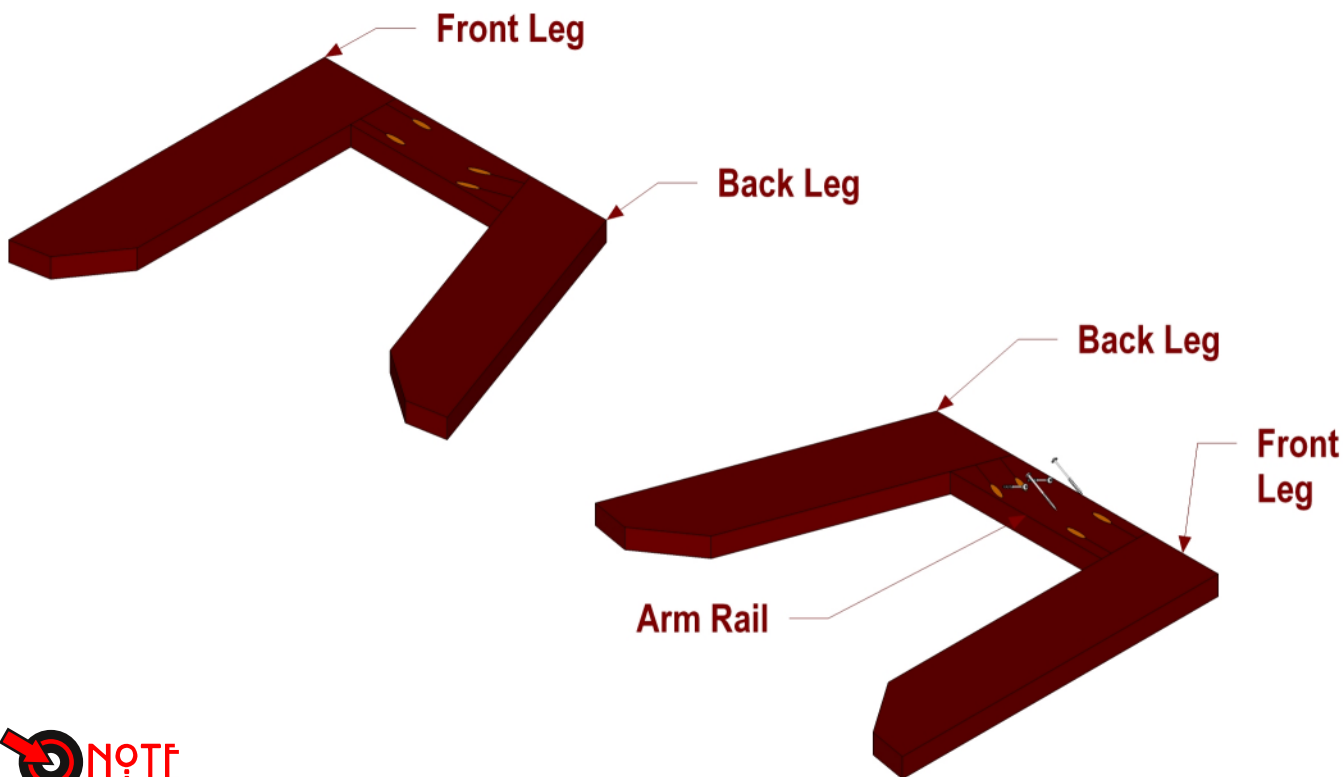

**NOTE**

Position the parts as shown and attach using 2 1/2" pocket hole screws.

**NOTE**

Position the Outer Arm Supports as shown and attach to the Legs and Arm Rails using 2 1/2" deck screws.

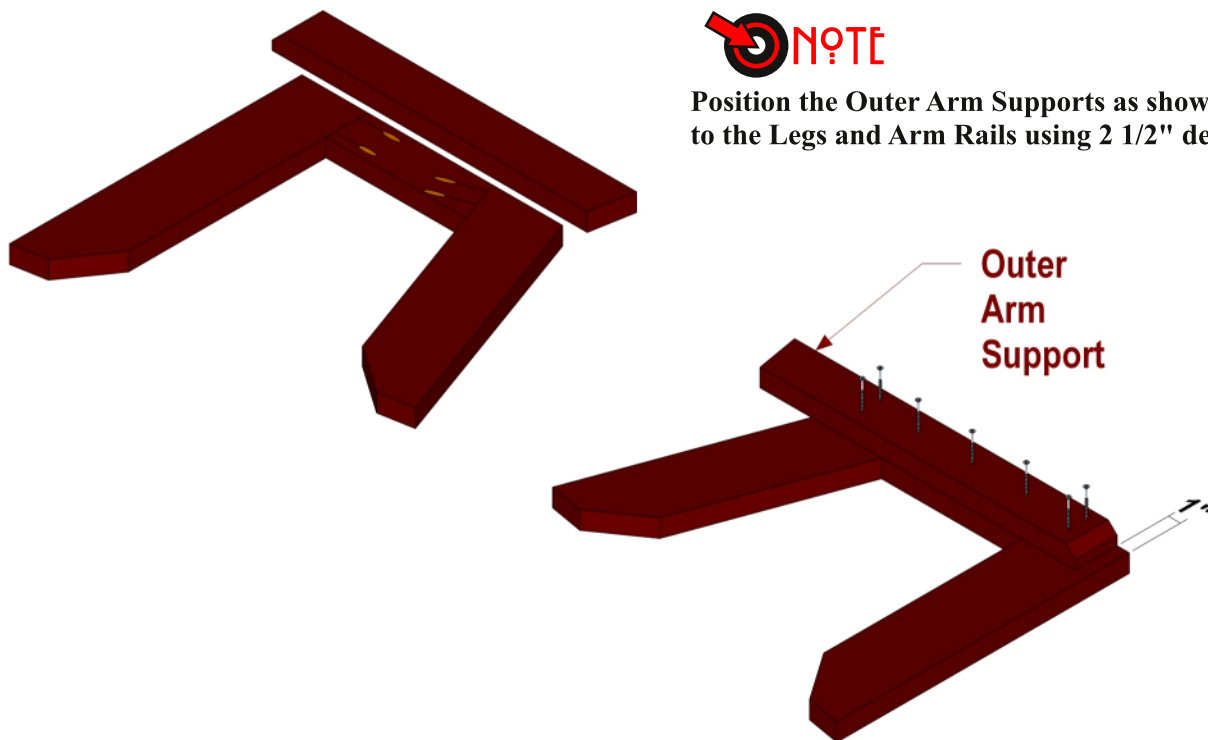

**Left Rail/Stretcher**

**LAYOUT**

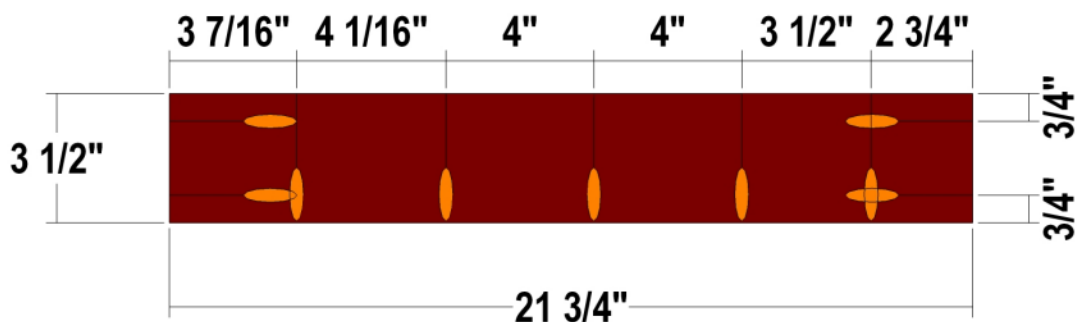

**NOTE**

Use the layout for creating the Left Rail, Right Rail, and Stretcher. Set your Kreg Jig and drill bit for 1 1/2" stock for the pocket holes.

**Right Rail**

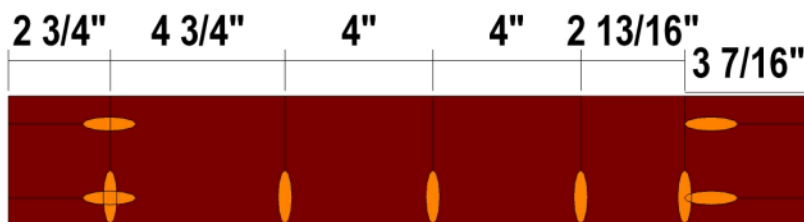

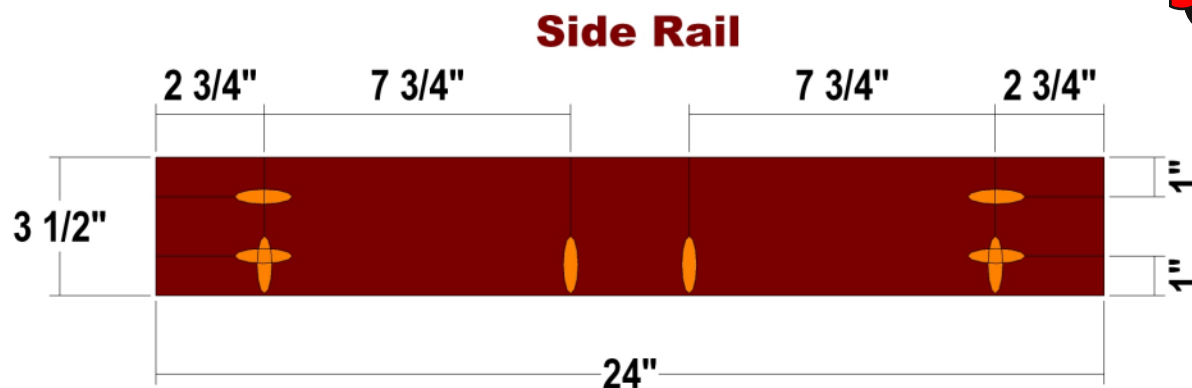

 NOTE

Use the layout for creating the Side Rails. Set your Kreg Jig and drill bit for 1 1/2" stock for the pocket holes.

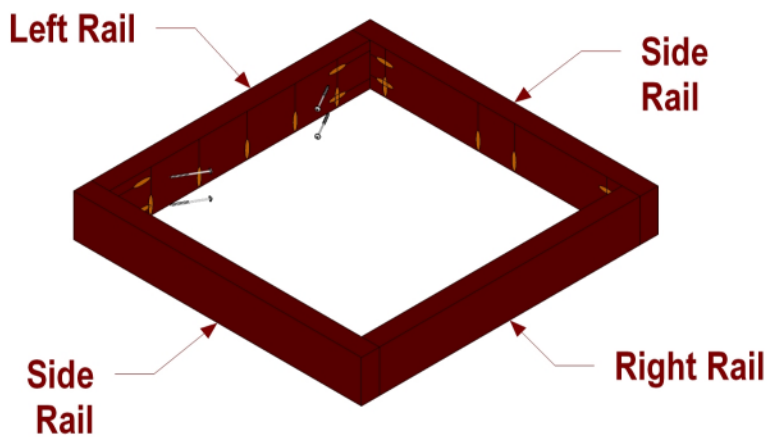

 NOTE

Position the parts as shown and attach using 2 1/2" pocket hole screws.

**Back Slat**

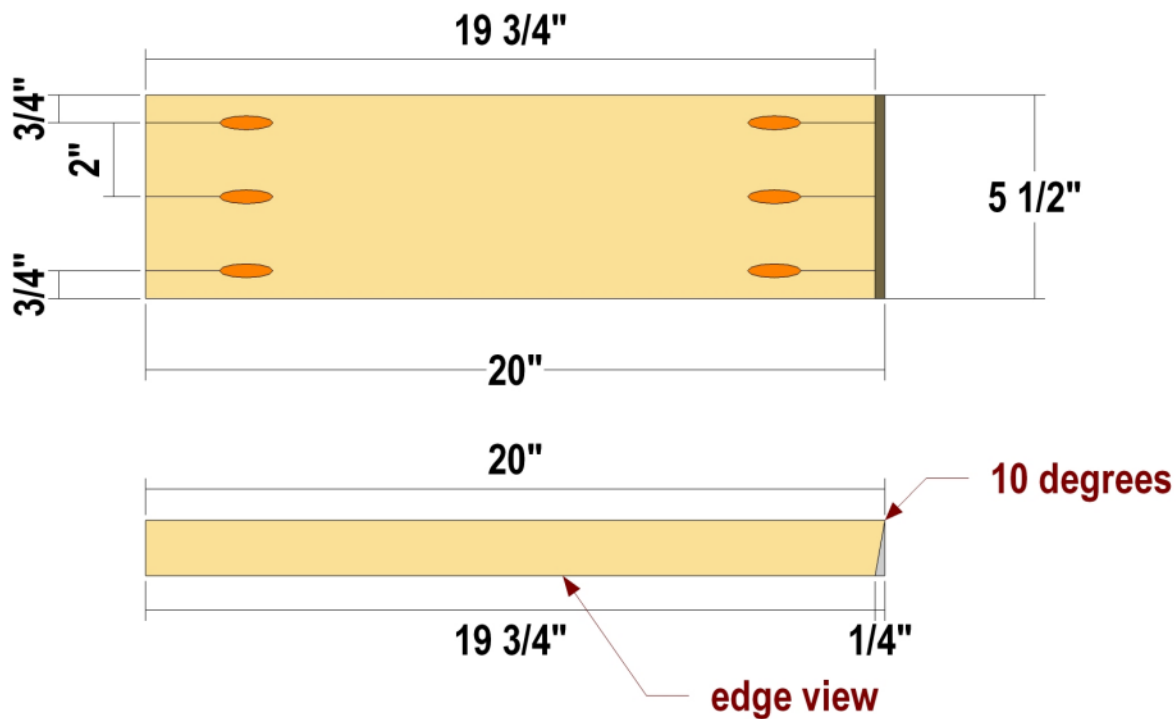

Use the layout for creating the Back Slats. Set your Kreg Jig and drill bit for 1 1/2" stock for the pocket holes. Drill the pocket holes on the bevel end after cutting the 10-degree bevel. You will need to remove the jig from its base and clamp it on the board when drilling the holes.

**Back Rail**

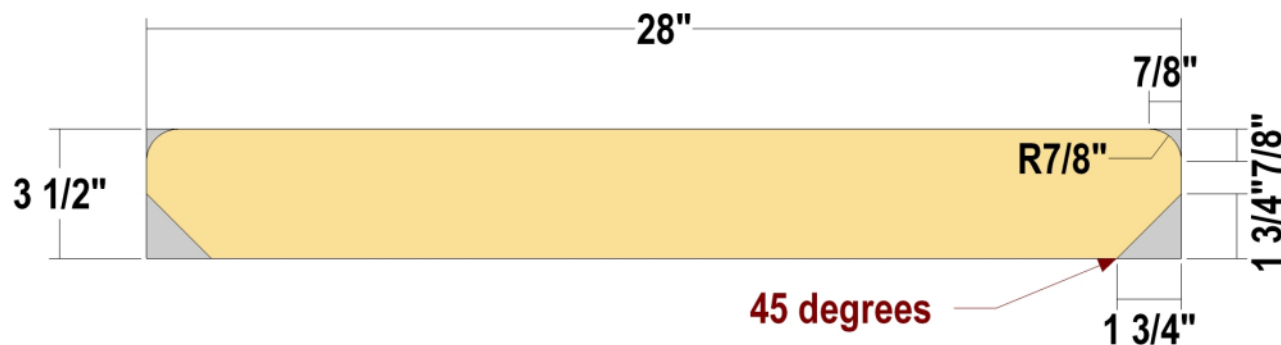

Use the layout for creating the Back Rail.

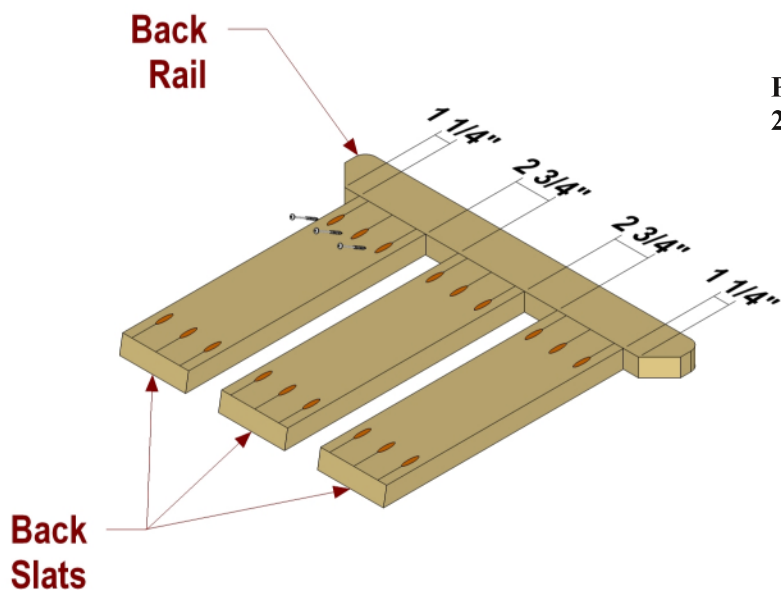

NOTE  
Position the parts as shown and attach using 2 1/2" pocket hole screws.



NOTE  
Position the parts as shown and attach using 2 1/2" pocket hole screws.

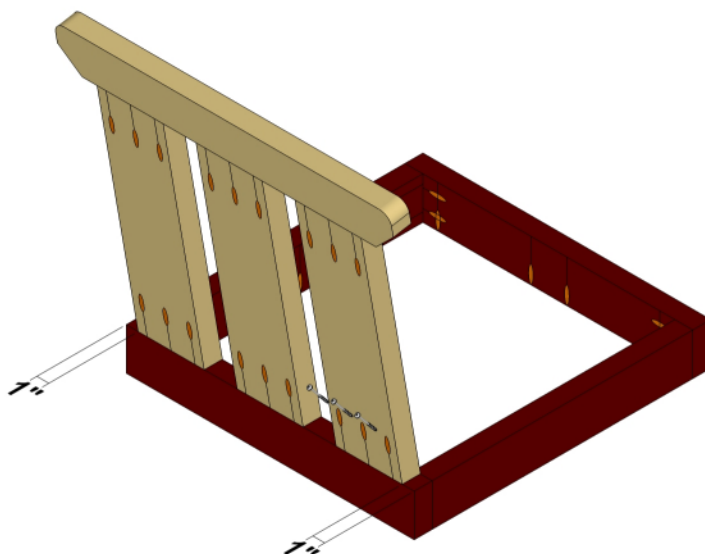

## NOTE

Position the Back/Rail assembly as shown, and attach to the Leg Assemblies using 2 1/2" pocket hole screws.

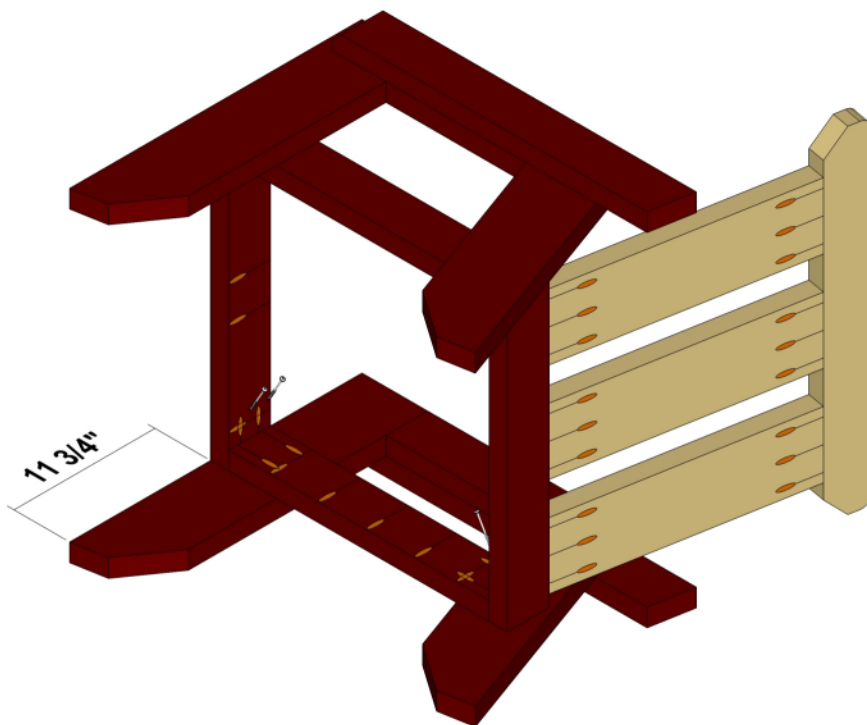
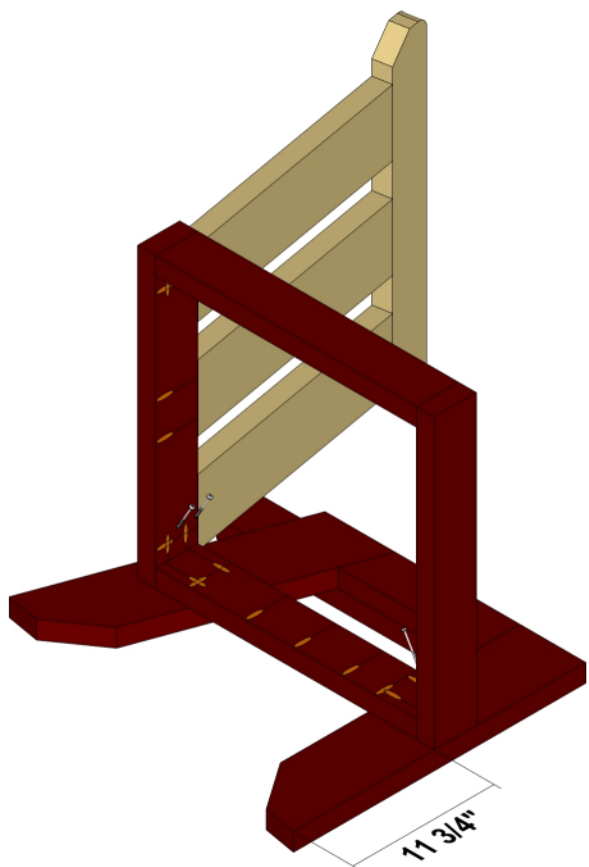



Back Support

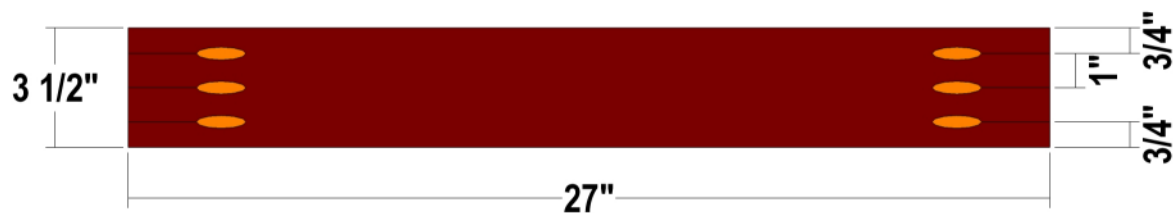

Use the layout for creating the Back Support. Set your Kreg Jig and drill bit for 1 1/2" stock for the pocket holes.

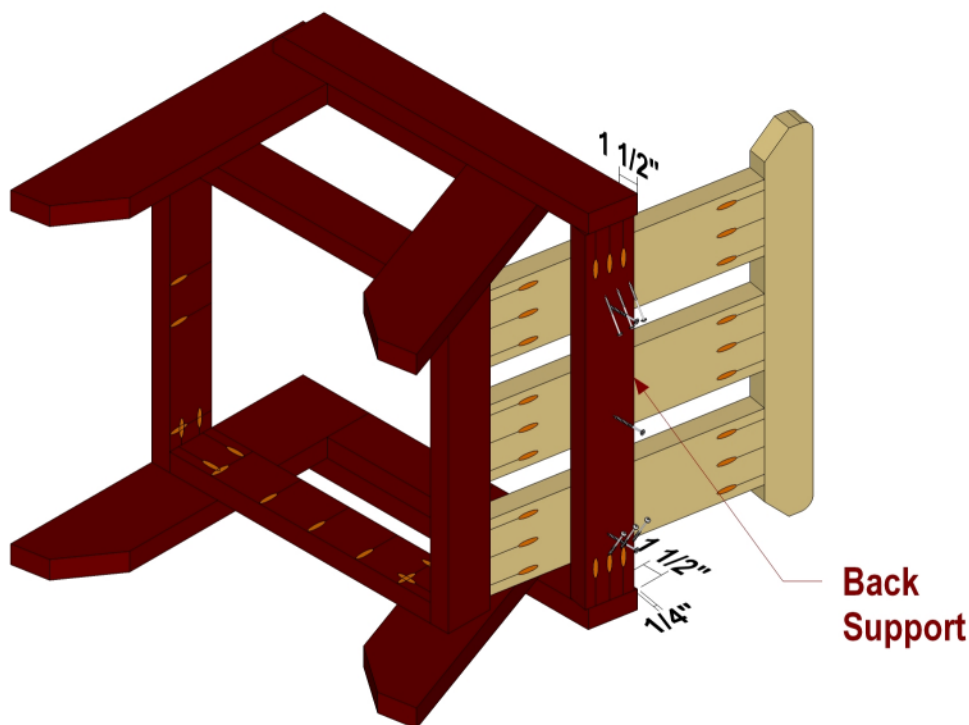

Position the Back Support flush against the Back Slats, and attach to the Outer Arm Supports using 2 1/2" pocket hole screws, and to the Back Slats using 2 1/2" deck screws. Make sure the top corner of the Back Support does not stand proud above the Outer Arm Supports.

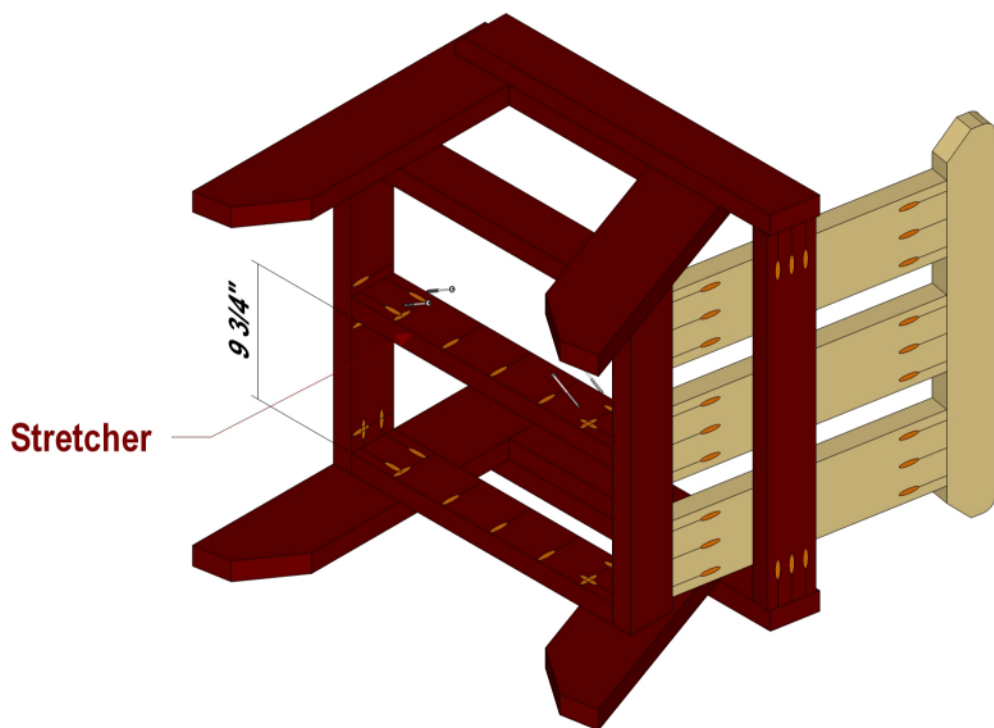

Position the Stretcher as shown, and attach to the Side Rails using 2 1/2" pocket hole screws.

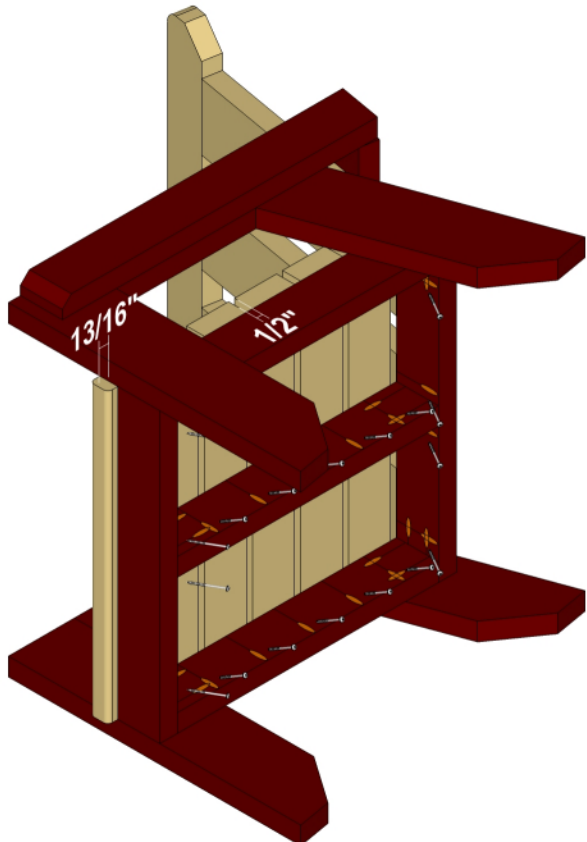

Position the Seat Slats as shown (the front slat extending 13/16" beyond the front, and remainder spaced 1/2" apart), and attach to the front Side Rail, Left Rail, Right Rail, and Stretcher using 2 1/2" pocket hole screws. Drive additional 2 1/2" pocket hole screws through the back Side Rail and into the Back Slats.

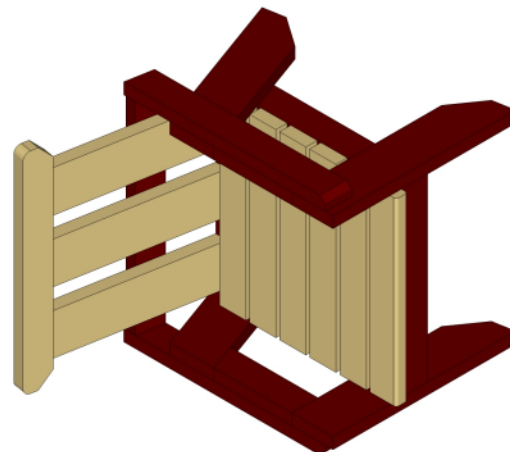

Arm

LAYOUT

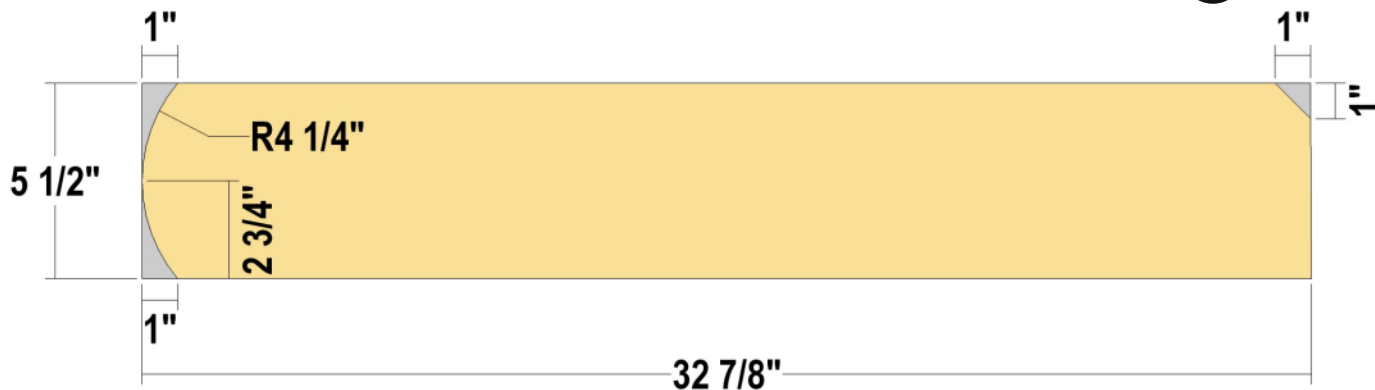

NOTE

Use the layout for creating the Arms.

NOTE

Position the Arms as shown (flush against the Back Slats and extending beyond them by 2 3/8"), and attach to the Arm Rails, Legs, and Outer Arm Supports using 2 1/2" deck screws.

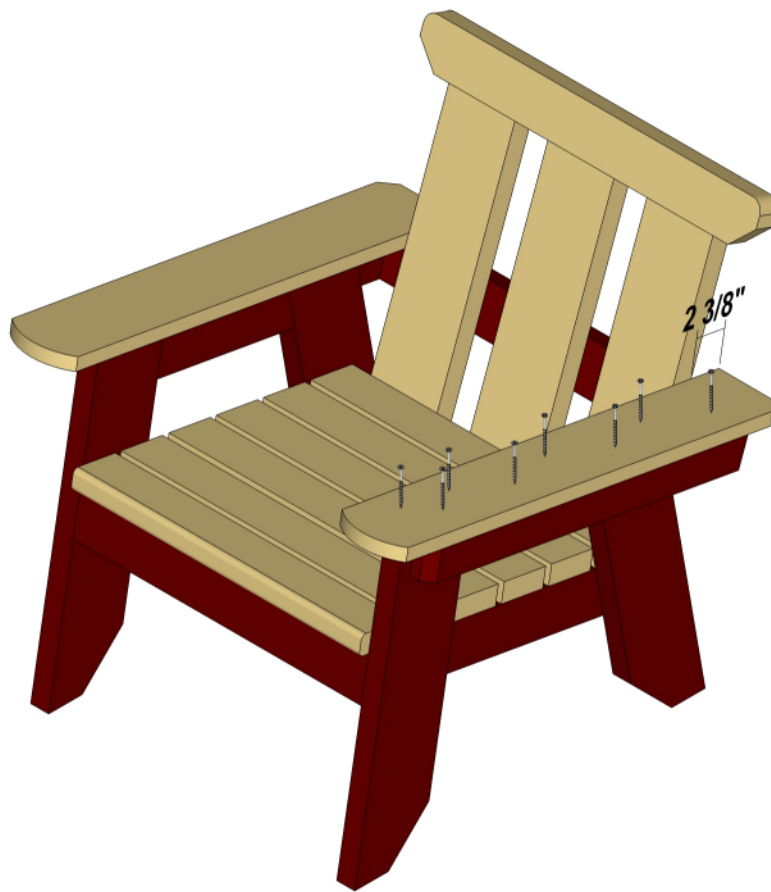

 **CUTTING DIAGRAM**

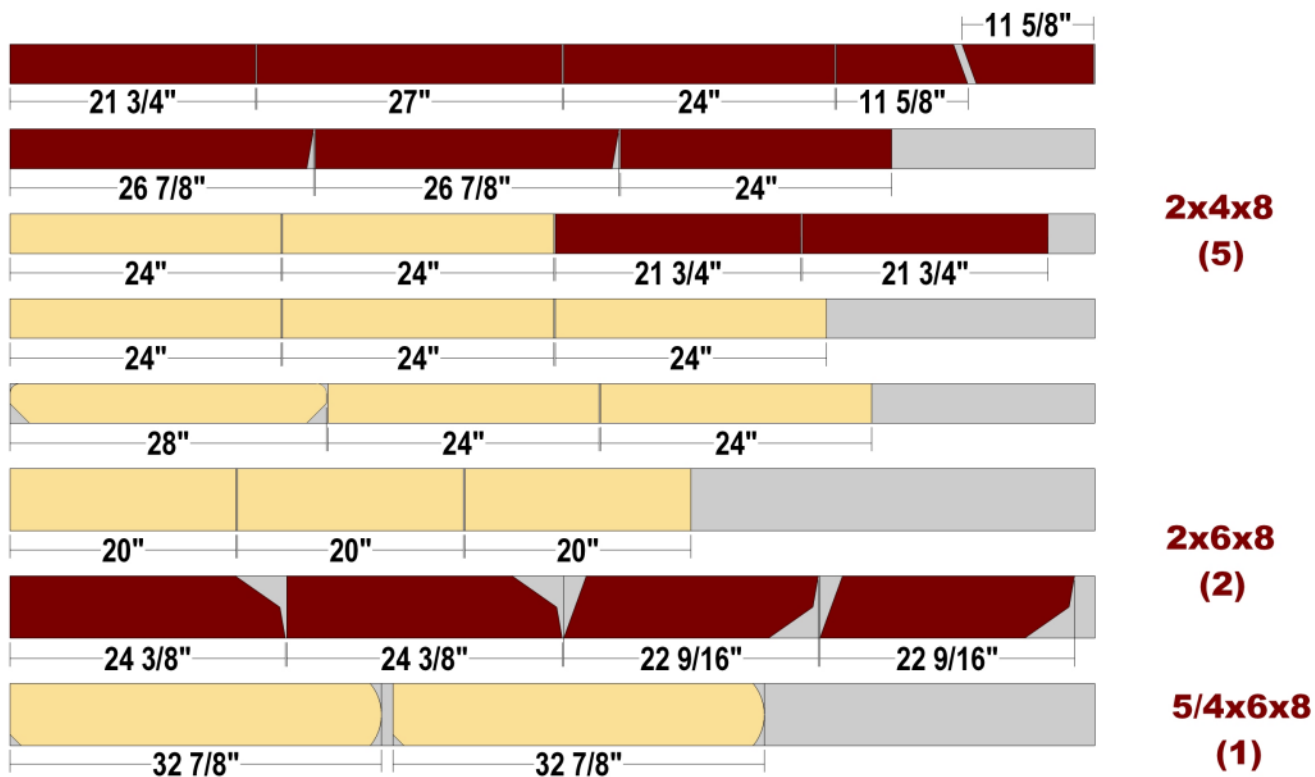

Estimated lumber cost: starting at \$40 for one

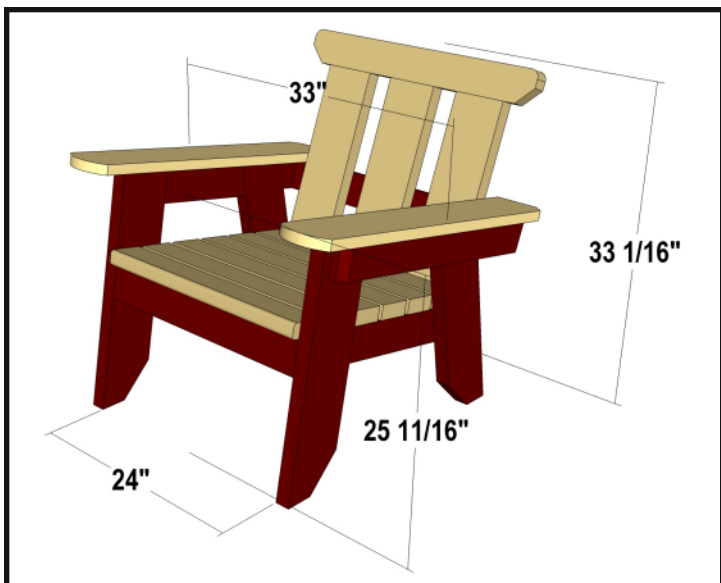

**PARTS**

front legs (2) - 1 1/2 x 5 1/2 x 24 3/8  
 back legs (2) - 1 1/2 x 5 1/2 x 22 9/16  
 arm rails (2) - 1 1/2 x 3 1/2 x 11 5/8  
 outer arm supports (2) - 1 1/2 x 3 1/2 x 26 7/8  
 left rail - 1 1/2 x 3 1/2 x 21 3/4  
 right rail - 1 1/2 x 3 1/2 x 21 3/4  
 side rails (2) - 1 1/2 x 3 1/2 x 24  
 back rail - 1 1/2 x 3 1/2 x 28  
 back slats (3) - 1 1/2 x 5 1/2 x 20  
 back support - 1 1/2 x 3 1/2 x 27  
 stretcher - 1 1/2 x 3 1/2 x 21 3/4  
 back support - 1 1/2 x 3 1/2 x 27  
 seat slats (7) - 1 1/2 x 3 1/2 x 24  
 arms (2) - 1 x 5 1/2 x 32 7/8

All parts are listed in actual dimensions. Refer to the Cutting Diagram on the last page of this plan as a guide for determining the specific board from which to cut the parts.

 **TAKE CARE!**

Follow ALL SAFETY GUIDELINES AND RECOMMENDATIONS provided by the manufacturers of your tools, and any chemicals such as glue and finishes you use in this project. YOU are responsible for your safety, so use common sense when working in the shop!